



STANDARD  
EQUIPMENT  
GUIDE

| LIOQA  
RESORT

This document serves as the homeowner's guide to understanding to what standard your property will be handed over. The other discussed topics are included in your villa's sales price. The standard equipment considers the latest global market trends, the unique atmosphere of the Mediterranean coast, and the **badge of a premium luxury second home**.

It is our pleasure to help you facilitate the final touch to your second home and discuss any technical or interior design items not mentioned in this document as part of the primary or premium package. These packages have been developed following the interior design of a world-class designer, **Marisa Gallo**. We will gladly support you by coordinating the project if you wish to collaborate with your designer.

**LIOQA**  
RESORT

 **MARISA GALLO**  
ARQUITECTURA DE INTERIORES

# Table Of Contents

---

Categorization	.....	3
Privacy & Safety	.....	4
Sports & Fun	.....	5
Beach Club	.....	6
Fence	.....	8
Garden	.....	9
Facade	.....	10
Soft technology	.....	11
Hard technology	.....	13
Tiles	.....	15
Windows	.....	16
Curtain Railings	.....	17
Door	.....	18
Stairs	.....	19
Kitchen	.....	20
Kitchen appliances	.....	21
Bathroom fittings	.....	22

Villa A+

# Categorization

To proudly wear the badge of a 5\* luxury resort, the project needs to undergo the categorization process, where the Croatian Ministry of Tourism will assign 5\* based on the regulations of the accommodation star-rating system.

Therefore, the resort and its units must meet all the categorization requirements by November 2023. To make this experience hassle-free, we have completed an interior design package to meet the categorization process standards and suit the needs of a design connoisseur.

A 5\* property rating serves as a guarantee of upscale quality and extraordinary comfort. The strict regulations of the star-assigning system ensure that guests are accommodated at a state-of-art facility.

MONDAY, MAY 27, 2013. NATIONAL NEWSPAPERS OFFICIAL GAZETTE OF THE REPUBLIC OF CROATIA NUMBER 63 - PAGE 107

16.2. Around objects	2*	3*	4*	5*	The result	Remarks
1. Good care and maintenance of the environment						
2. Labels in good condition: no stains or visible wear						
3. Good functioning of lighting, if any						

17.1. Maintenance	2*	3*	4*	5*	The result	Remarks
1. The maintenance of tourist settlements is ensured continuously						

APPENDIX VI. CONDITIONS FOR CATEGORIZATION OF TOURIST SETTLEMENT - NEW FACILITIES

dark field means mandatory application

TOURISTS' WHO SETTLEMENT						
1. RECEPTION SERVICES AND OTHERS						
1.1. Reception	2*	3*	4*	5*	The result	Remarks
1. Covered entrance to the reception hall with a reception desk (overhead above the entrance door)						
2. Notice of working hours displayed at the entrance						
3. Separate reception area: entrance area and reception desk. Exceptionally, in a tourist resort with up to 25 accommodation units, a reception area with a reception desk or similar						
4. The reception is open 16 hours a day. At other times, the reception is available upon request						
5. The reception is open 24 hours a day						
6. House rules in Croatian and at least in English						
7. Price list of accommodation units at the reception in Croatian and at least in English						
8. Telephone switchboard with at least two direct lines						
9. Mail and message delivery services to the guest						
10. In a tourist resort with more than 25 accommodation units, a receptionist in uniform with a plate with the person's name						
11. In a tourist resort with up to 25 accommodation units, a person providing reception services is provided						
12. Receptionist in uniform with a plate with the person's name						
13. Chairs, etc. with a low table that can be moved						
14. Smoking prohibition sign						
1.2. Comfort/general	2*	3*	4*	5*	The result	Remarks
1. Heating. Exceptionally, it does not apply to tourist resorts that operate in the summer						
2. Air conditioning						
1.3. Contents and services	2*	3*	4*	5*	The result	Remarks
1. The possibility of using the phone for internal and external calls						
2. Fax service						
3. Email service						
4. Chief. Exceptionally, it does not apply to facilities that have a safe in the accommodation units						
5. Color TV in the area with possible seating. Exceptionally, it does not apply to tourist resorts that have color TV in accommodation units.						
6. Trolleys for transporting luggage at the guest's disposal						
7. Organized luggage transfer						
8. Parking for motor vehicles for at least 20% of accommodation units, unless otherwise prescribed by this Ordinance						
9. Parking for motor vehicles for at least 25% of the accommodation units and covered parking for at least 10% of the accommodation units, unless otherwise prescribed by this Ordinance						



# Complete Privacy, Assured Safety.

Our private LIOQA Resort is equipped with 24/7 security located at the reception and a gated community entrance. All roads are fitted with street lighting that is motion-sensor activated at night to ensure privacy yet safety at night time.

In addition, the resort is fitted with CCTV cameras to keep you, your family, your friends, and your property safe.



## Manage Your Guests

LIOQA's parking system is running on SKIDATA's platform, which allows you to individually manage your visitors by simply entering their license plate into the system.

**SKIDATA**  
KUDELSKI GROUP



# Sports And Fun

To guarantee a well-spent stay, we equipped the resort with a multi-purpose court 20x40m, where you can enjoy tennis, volleyball, basketball, and handball with your friends and family.

In addition, an outdoor workout area will be built right by the beach.

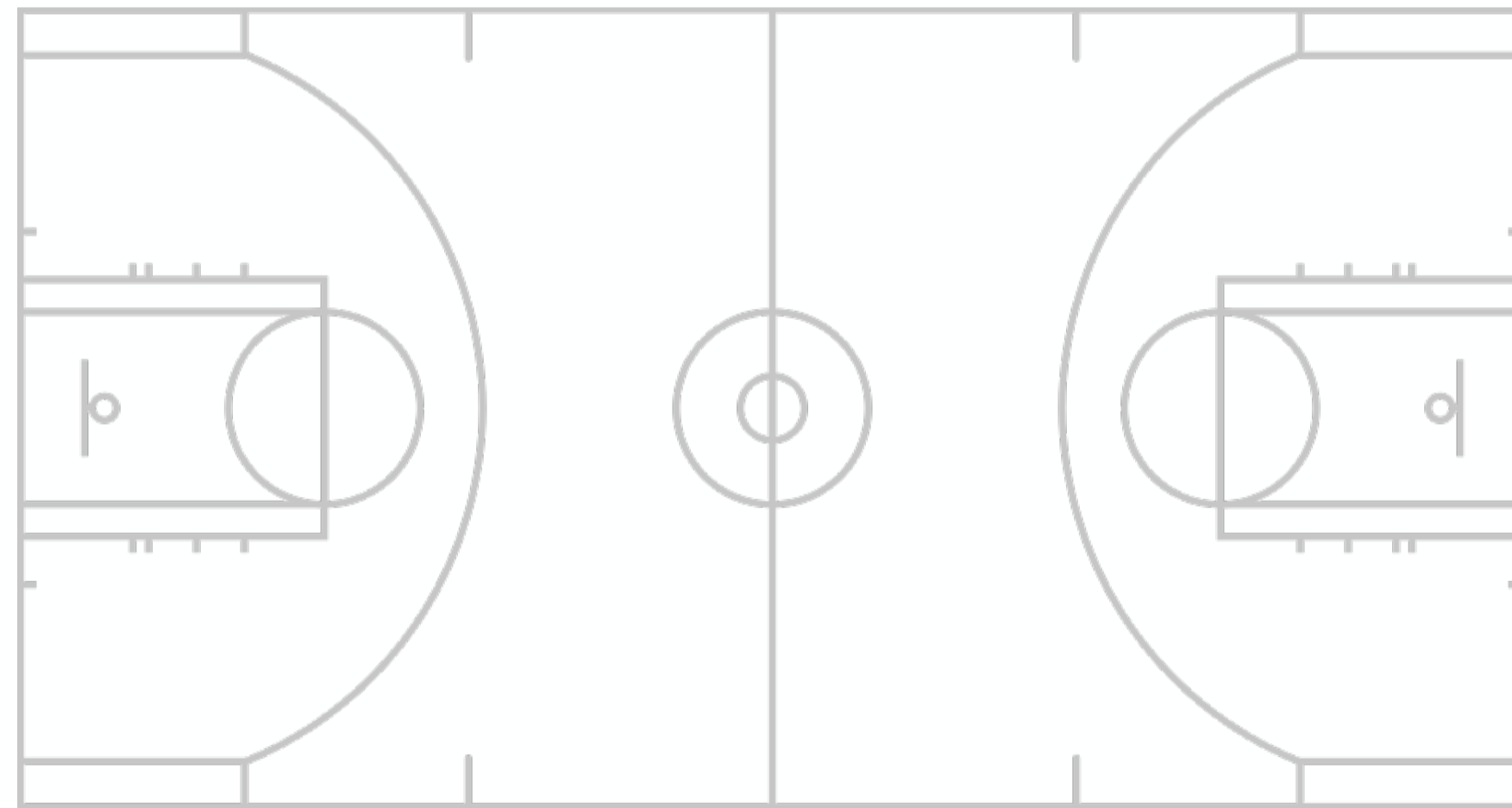

## Beach Club

Combining dining, good wine, sun tan, and art, all in the omnipresent Mediterranean atmosphere, we bring you the exclusive LIOQA Resort's VIVA Beach Club.

All owners and renters have access to the amenities of the beach club as per the standard operating hours, as well as a discount for all F&Bs.

## Dining

LIOQA Resort's restaurant is there to ensure high-quality local food from breakfast to dinner. In addition, an AirStream food truck will be available during the daytime by the beach for quick but delicious bites and drinks.

All owners and renters have access to the amenities of the beach club as per the standard operating hours, as well as a discount for all F&Bs.

## Pool

Two community pools are available for the resort's guests in the beach club area. The main pool is 1.5m deep, while kids can swim safely in the 0.3m deep pool.



VIVA

BEACH CLUB

Villa A+

STANDARD  
EQUIPMENT  
GUIDE

LIOQA  
RESORT





# Fence

Your property is protected with a combination of a concrete fence with an aesthetical surface finish in combination with Betafence by CreaZen, with a width of 2400 mm for each panel and a double swing gate opening fence.

The modern stairs leading to the entrance of your villa are made from precast structural concrete and are emphasized by an LED backlight.



**B** **BETAFENCE**



# Garden

Each plot, including yours, is made from three sections: the planting zone, the dry garden, and the hedges.

The planting zone combines alluring flowers like *Verbena bonariensis*, *Agapanthus africanus*, *Santolina chamaecyparissus*, etc. The dry garden includes plants such as *Rosmarinus prostrates*, *Stachys byzantine*, or *Agave americana*. The plot is enclosed with bushes to aesthetically cover the security fence. Lastly, the spacious lawn on flat surfaces surrounding your property is maintained by an automatic lawn mower provided by us.

The resort, as well as your plot, is equipped with an irrigation system managed by the resort's gardening team for an effortlessly groomed lawn and always trimmed hedges.

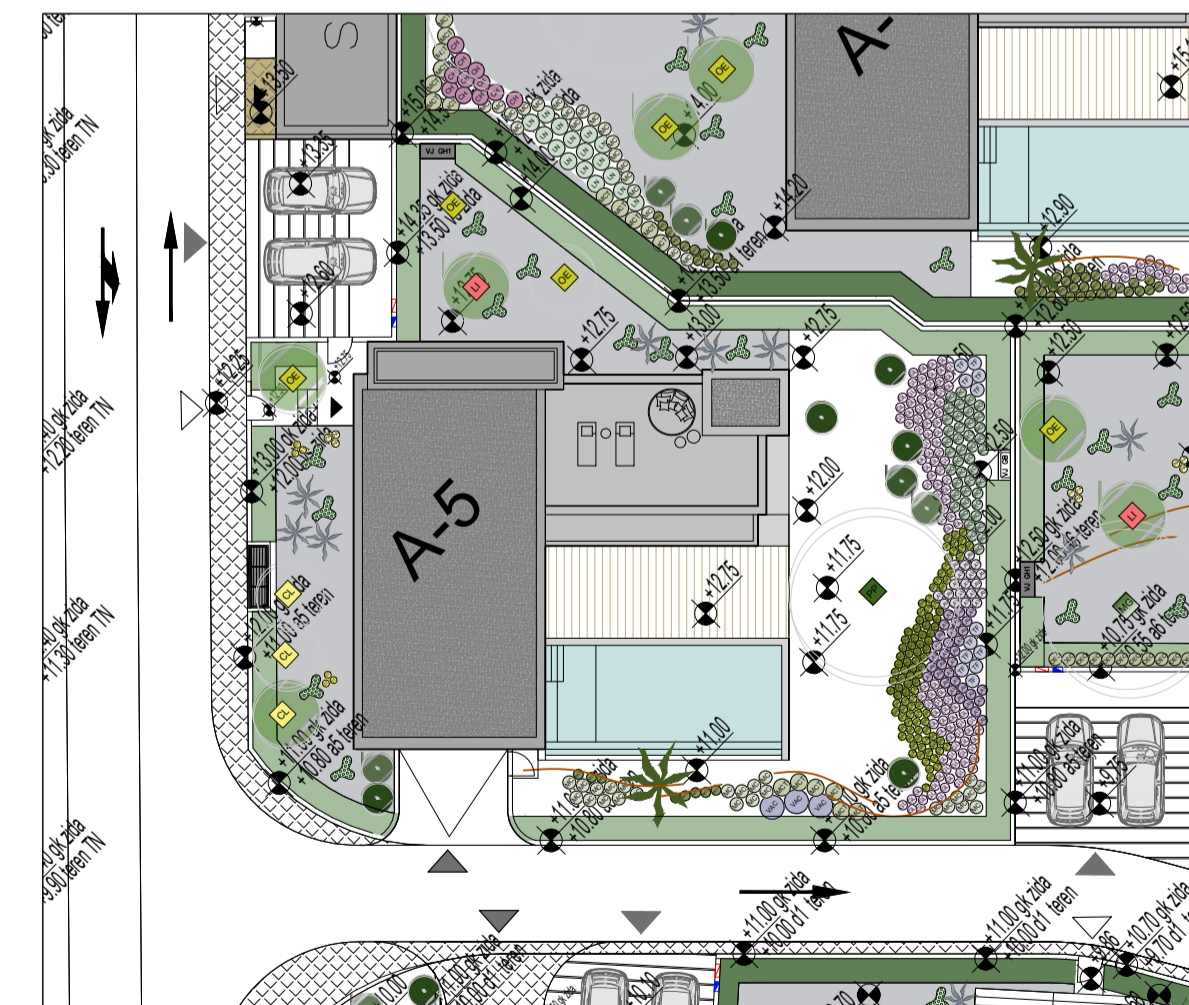

# Facade

**EQUITONE®**  
Fibre cement facade materials

The villa is finished with Equitone Tectiva, a through-colored facade characterized by a sanded surface and naturally occurring hues. These fire-safe, sound-insulating, and highly resistant panels provide a smooth and classic colorful accent with no visible fibers. Equitone Pictura is combined with a decorative painting finish, Rofix Premium.

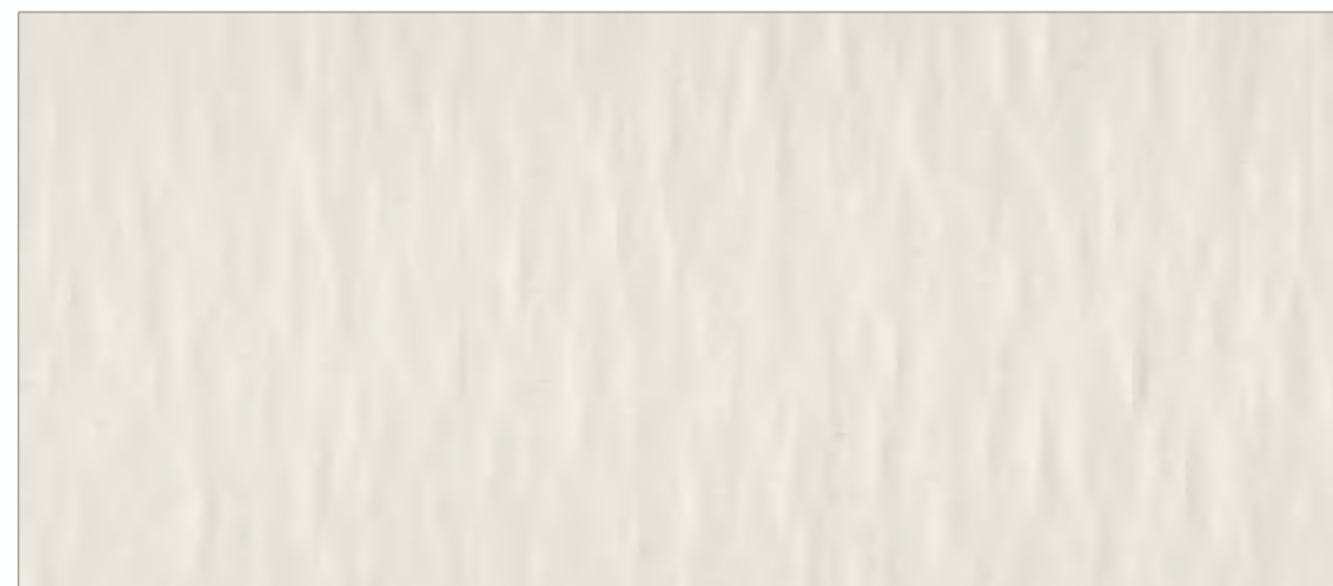

TE90



TE10



TE60

## Interior Ceiling

All ceilings are gypsum plaster board double-coated in white color.

## Interior Walls

All walls are painted in white color.

## Garage, Basement & Technical Room Ceiling

The fair-faced concrete is painted with a decorative coat in white (RAL9010).



# Soft Technology

KNX is a globally established, wired system for the smart control of the home and building technology. The KNX Secure security standard ensures that all data transmissions in the KNX Smart Home are encrypted - and thus protected.

The Gira smart-home system, together with KNX protocol, provides a solution that intelligently and flexibly targets everyday needs, such as lighting, blinds, HVAC, or music. These fire-safe, sound-insulating, and highly resistant panels provide a smooth and classic colorful accent with no visible fibers.



- KNX PROTOCOL
- GIRA G1 TOUCH PANEL
- GIRA S1
- GIRA X1
- OPTICAL WIRING PROVIDED BY HRVATSKI TELEKOM
- CAT6 CABLING IN LIVING ROOM AND BEDROOMS
- HIGH SPEED INTERNET
- SPEAKERS BOWER & WILKINS (CCM684)



## GIRA

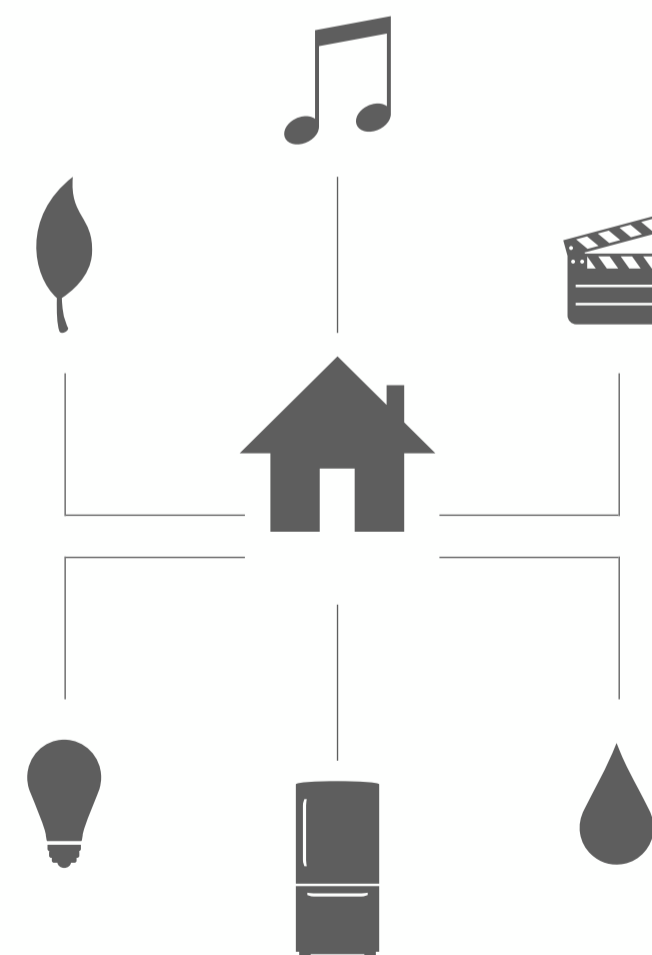

# See Nothing, Hear Everything

It has 19 speakers strategically distributed in one villa to provide a unique listening experience.

The CCM684 is a high-performance ceiling speaker by Bowers & Wilkins. A two-way design featuring a 200mm (8in) woven glass fiber cone bass/midrange driver and a soft dome tweeter in a neat circular ceiling mount chassis.

## Bowers & Wilkins





STANDARD  
EQUIPMENT  
GUIDE

LIOQA  
RESORT

Villa A+

STANDARD  
EQUIPMENT  
GUIDE

LIOQA  
RESORT

## Hard Technology

Your villa is equipped with KAN-Therm TBS floor heating, using the dry method, furthermore for the highest achievable comfort, the climate ceiling cooling by Pagitsch, fan coil units, pre-wiring for photovoltaic solar panels, and water irrigation on green areas around your property.

The HVAC is supported by a Daikin Altherma heating pump based on the air-water system. All technical equipment is fully controllable via your homeowner's app and the Gira system.

## Many functions, One system

Your villa includes a private infinity pool with heating and cooling, filtering, water jets, and an outdoor shower.





Your pool's heat pump of brand Aquark Mr. Silence is controllable by Wi-Fi and preferred for its extra quiet technology.

 **DAIKIN**

# Tiles



All tiles in your villa are designed from a single collection GEA (color code AV) by an Italian manufacturer La Faenza Ceramica, thus allowing for smooth transitions from one room to another.

Wall tile		120cm x 120cm	thickness 6,5mm
Indoor floor tile		90cm x 90cm	thickness 6,5mm
Bathroom floor tile		30cm x 60cm	thickness 6,5mm
Terrace floor tile		90cm x 90cm	thickness 20 mm

In the interior, all tiles are of the same thickness (6,5-9mm), while in the exterior, such as the outdoor terrace, the large-format tiles of 2cm are stabilized on paving support pedestals. Specially manufactured tiles surround the pool with bull-nose coping.





# Windows

Panoramic floor-to-ceiling height windows and sliding doors from Cortizo's premium collection CorVisionPlus with a minimalist sliding system with a visible central interlocking system of just 25mm, providing an outstanding thermal and acoustic performance while delivering a solution with drainage, hidden rails, and maximum security.



To combine a pleasing design with an effective function, HELLA front-mounted vertical awnings are installed on all panoramic windows and are fully controllable by the smart-home system. The technology includes a wind sensor with an automatic roll-up system to prevent damage.



## Curtain Railings

To deliver an effortless high-tech household, we equipped your villa with pre-works for a motorized system for interior curtains that is fully controllable via Gira.

The KNX protocol provides the pre-works for electrically controlled curtains, as the cut-outs in the gypsum plasterboard slabs are ready for motorized curtains installations.

Please be informed that the motors, railings, curtains, and installation are not part of standard equipment. However, we cooperated with Marisa Gallo and her studio Interiorisimo, a world-class interior design architect, to provide you with a design we can facilitate and implement for you and your villa.

### Recommendation

For best effectiveness, we highly recommend SOMFY motors Glydea® ULTRA Motors 35 1003150 or 60 DCT 1003157 with RS485 - Somfy Digital Network™ RS485

**somfy**®

## Door

The stylish pivot doors leading to your villa are 2,90m high, and the material accommodates the façade. The inside doors, 2,65m in height, are modern, frameless, and wooden, and the standard includes a doorknob. All doors are equipped with locks.

Modern and elegant sectional garage door\* by Hörmann with Silkgrain surface finishing unifies the façade and the garage entering effortlessly.

# Stairs

The indoor concrete stairs are covered with wood for a soft and cozy feeling and are framed with vertical fencing going from floor to ceiling.

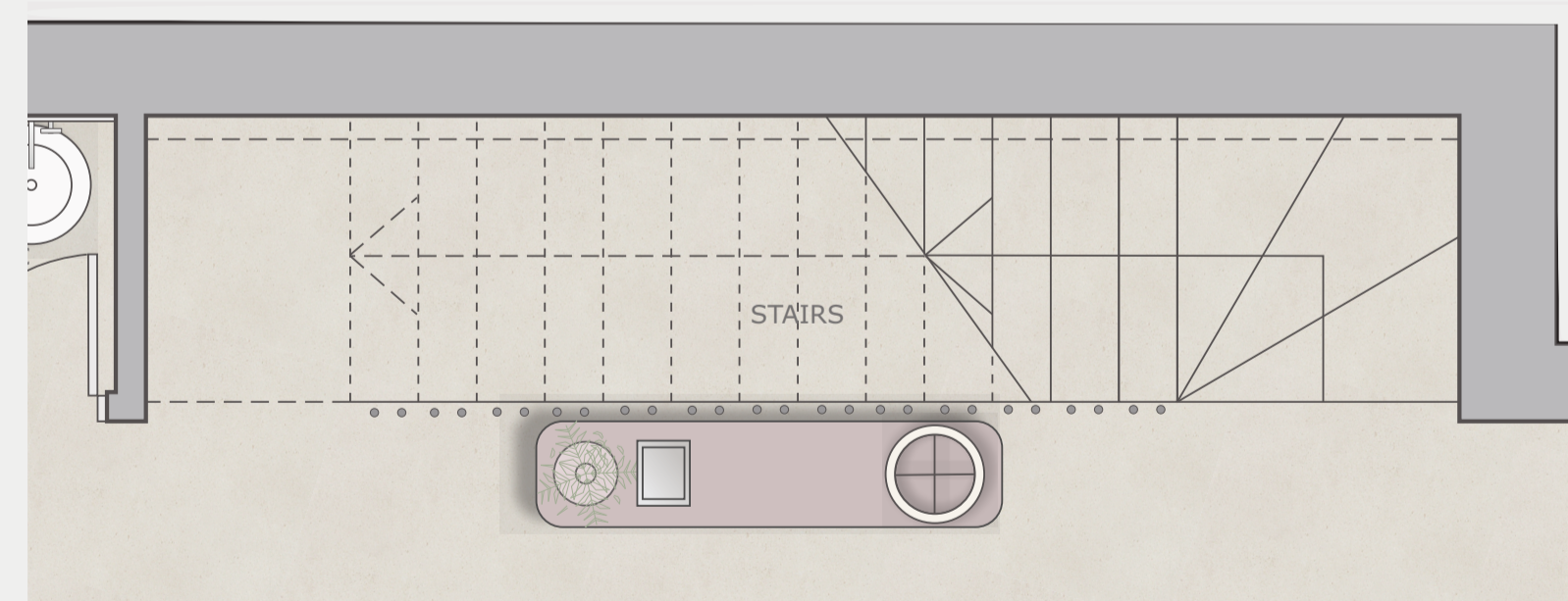

# Kitchen

Thanks to SieMatic's SLC kitchen and its exceptional lighting concept, its indirect illumination of the recessed channel creates visual accents while providing the practicality of a handle-free and design-oriented aesthetic principle.

The back wall is in SieMatic's Sterling grey specification, while the island is in Graphite grey, and the desk is TechniStone in Taurus Terrazzo Dark Matt.

The kitchen is fully equipped with premium quality kitchen electronics by Miele.

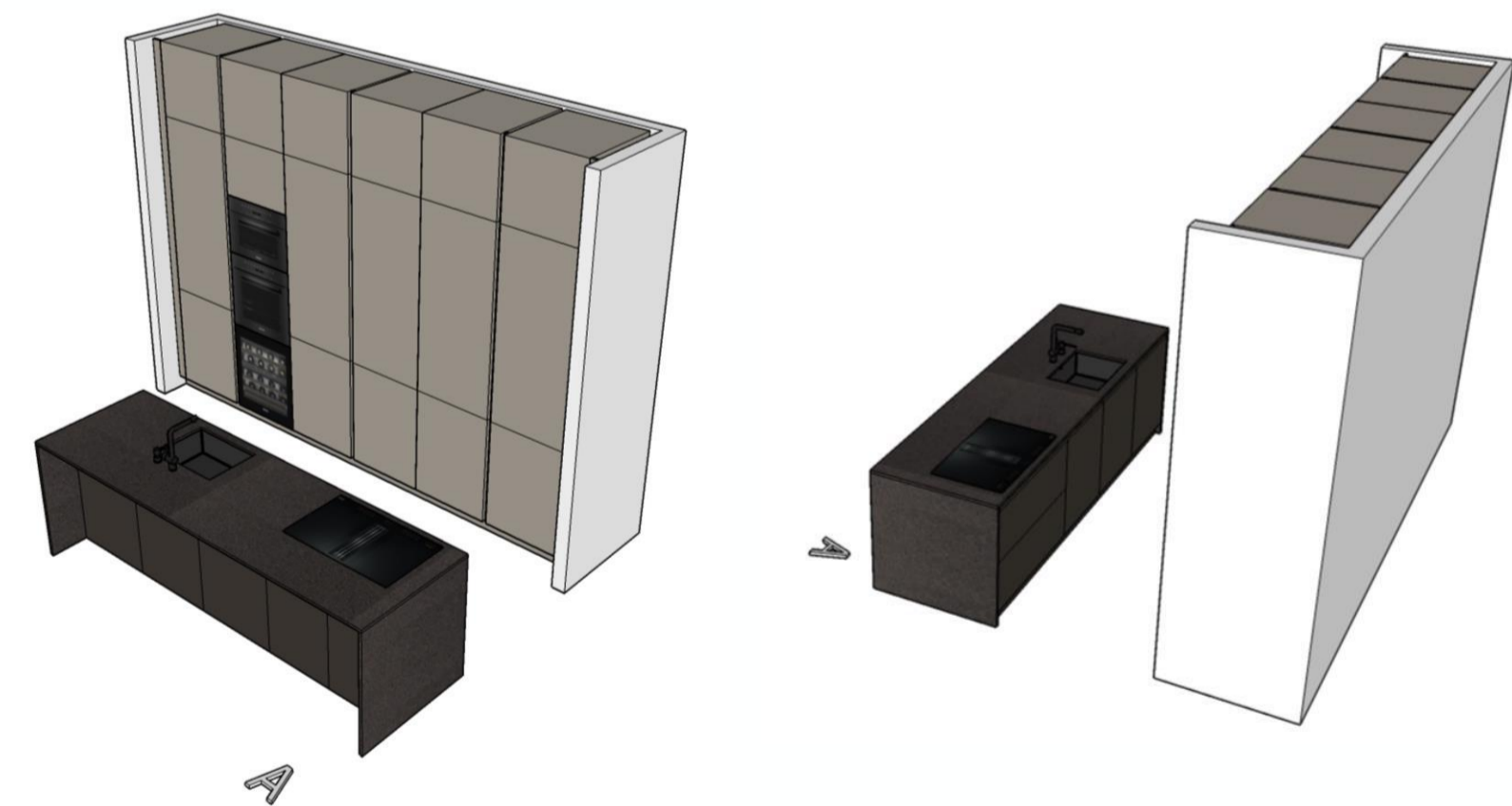

Sterling Grey



Graphite Grey



# Kitchen Appliances **Miele**

1. Miele G 5260 SCVi Active Plus  
Fully integrated dishwasher for optimal drying results thanks to the AutoOpen solution.
2. Fridge KFN 773F  
Combined fridge and freezer for optimal storage thanks to DynaCool and NoFrost technology.
3. Miele H 7264B  
Oven with a smooth design, possible connection over Wi-Fi, text display, and PerfectClean solution for easy cleaning.
4. Miele M 7244 TC  
Integrated microwave with a combinable design with an integrated grill, automatic programs for defrosting with a large capacity of 46l.
5. Miele KWT 6322 UG  
Built-under wine conditioning unit with FlexiFrame and Push2open for greater versatility and top-quality design.
6. Miele KMDA 7476FL  
Induction hob with an integrated hood for effortless design with a vapor extraction through the floor to the exterior.



# Bathroom Fittings



All bathrooms are fully fitted with ceramics by Duravit, which is known for its seamless design, high quality, and impressive durability.

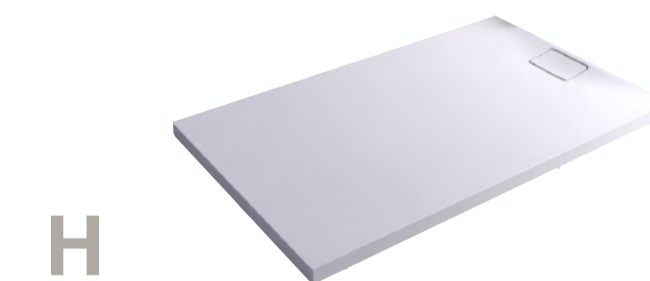
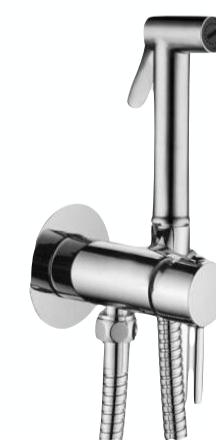
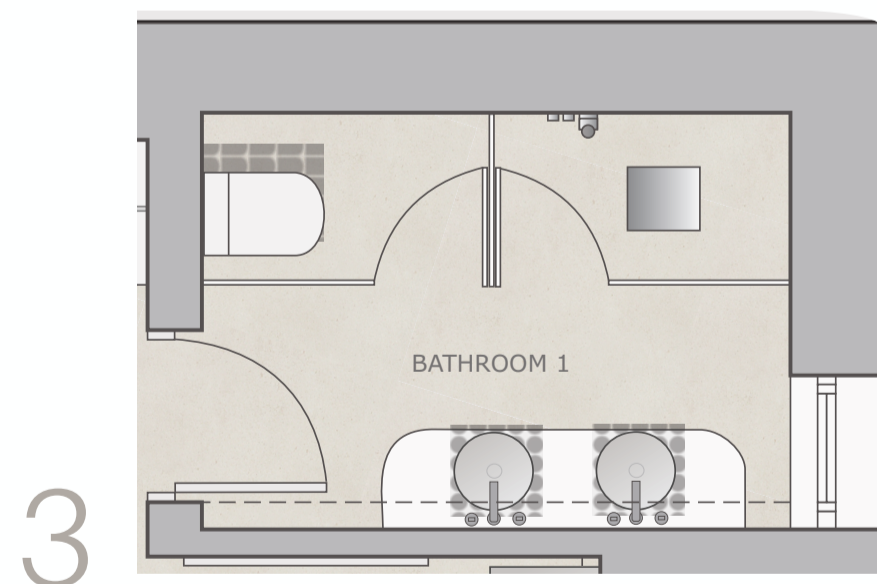
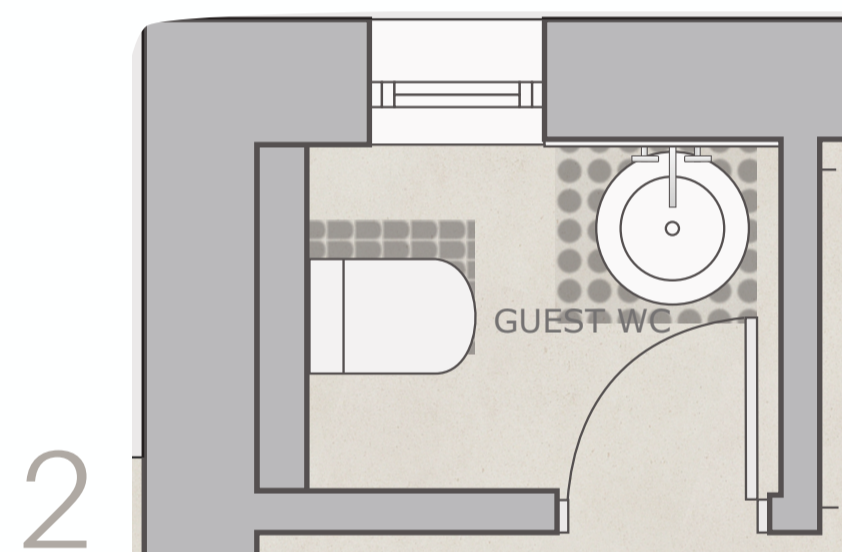
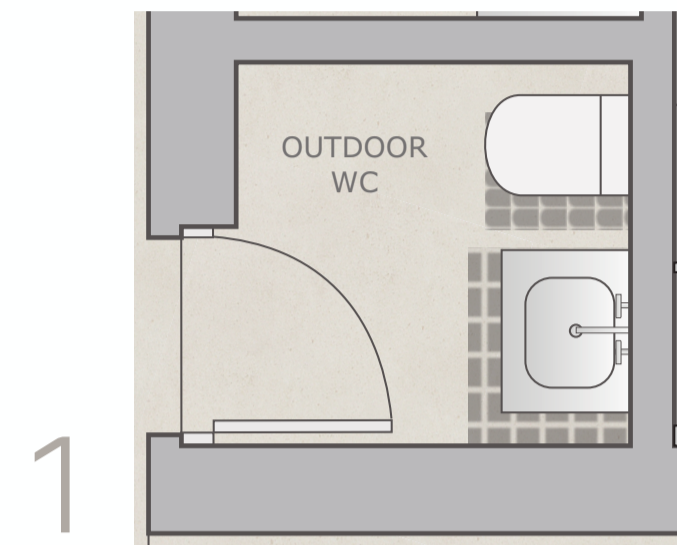

A Toilet ME by Starck white DURAVIT with Glass White actuator plate B Paffoni Bidet Kit C DURAVIT XViU Vanity Unit Floor Standing D DURAVIT White Tulip Washbasin freestanding E DURAVIT White Tulip Single Lever Basin Mixer F DURAVIT White Tulip Washbasin G DURAVIT Stick hand shower MinusFlow with wall mounted holder H DURAVIT Shower tray Stonetto with Showerhead jet



# Bathroom Fittings

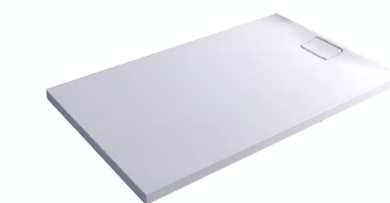
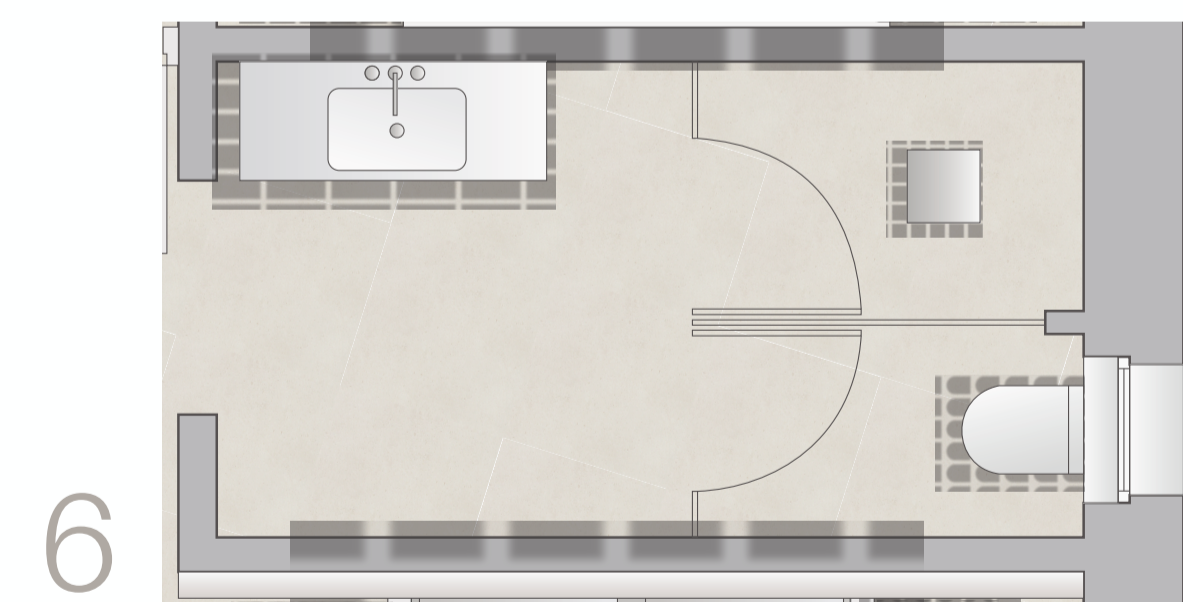
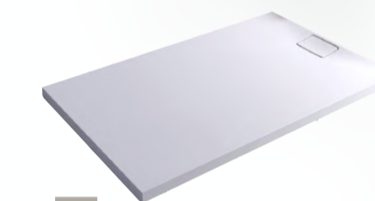
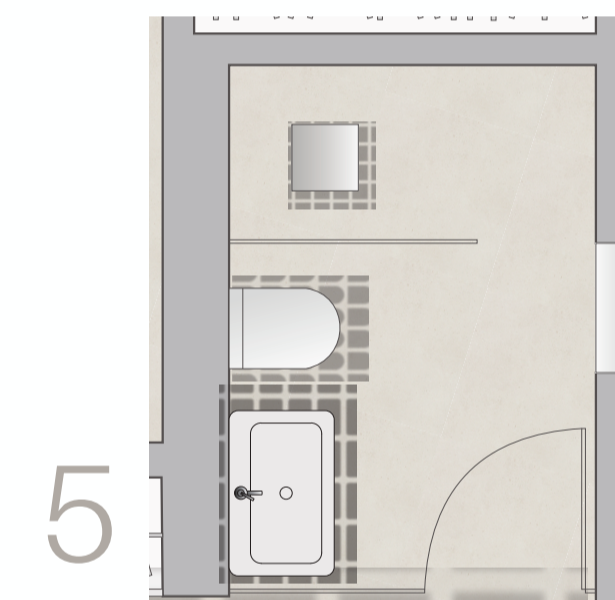
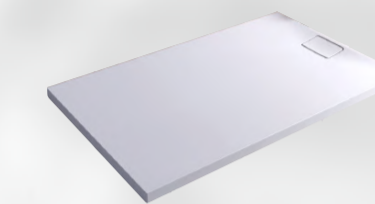
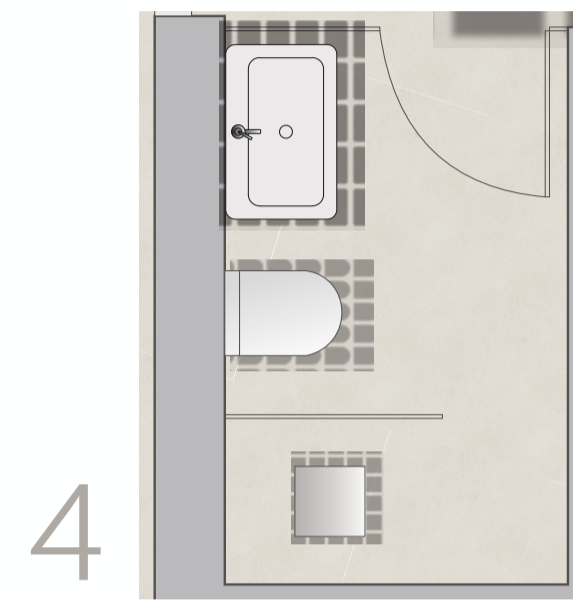
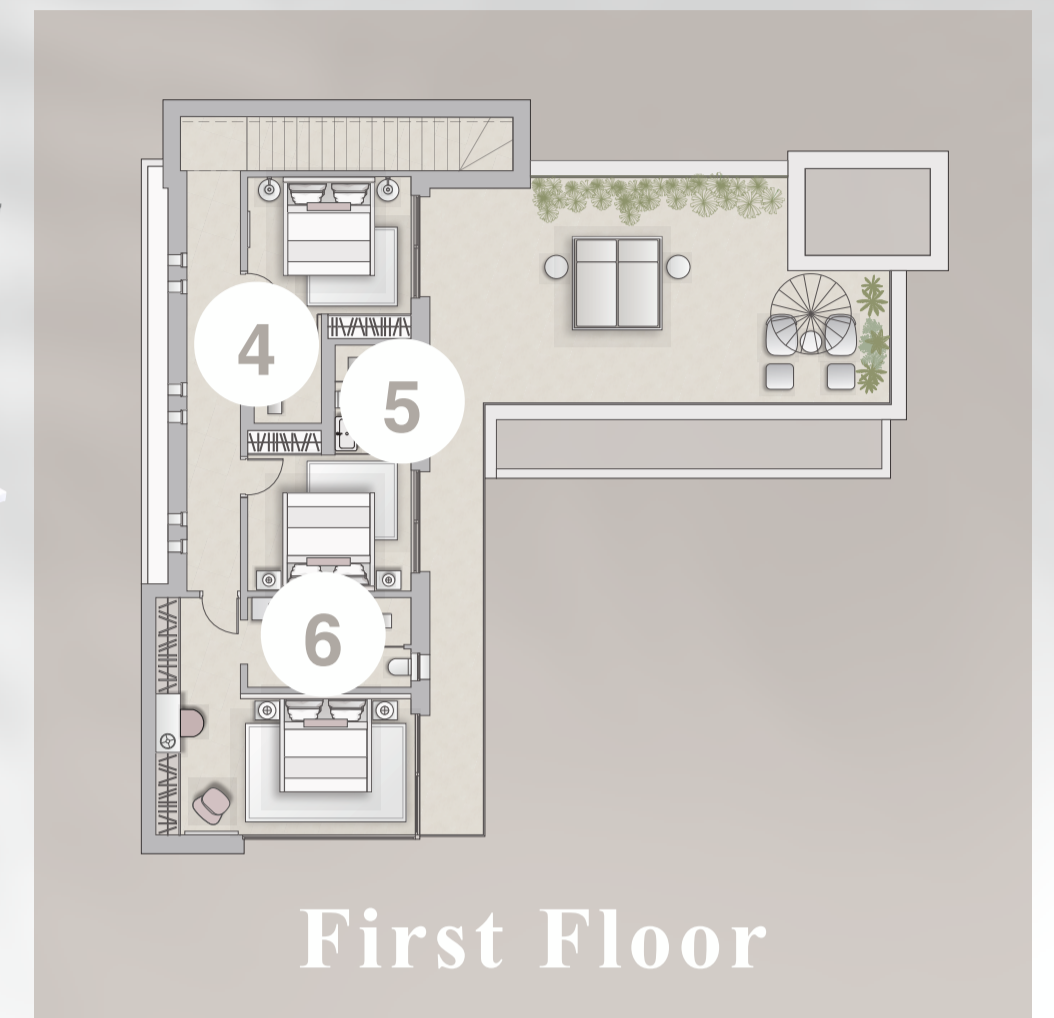

A Toilet ME by Starck white DURAVIT with Glass White actuator plate B Paffoni Bidet Kit C DURAVIT XViU Vanity Unit Floor Standing D DURAVIT Single Lever Basin Mixer E DURAVIT Stick hand shower MinusFlow with wall mounted holder F DURAVIT Shower tray Stonetto with Showerhead jet DURAVIT G DURAVIT White Tulip Washbasin





# Bathroom Fittings

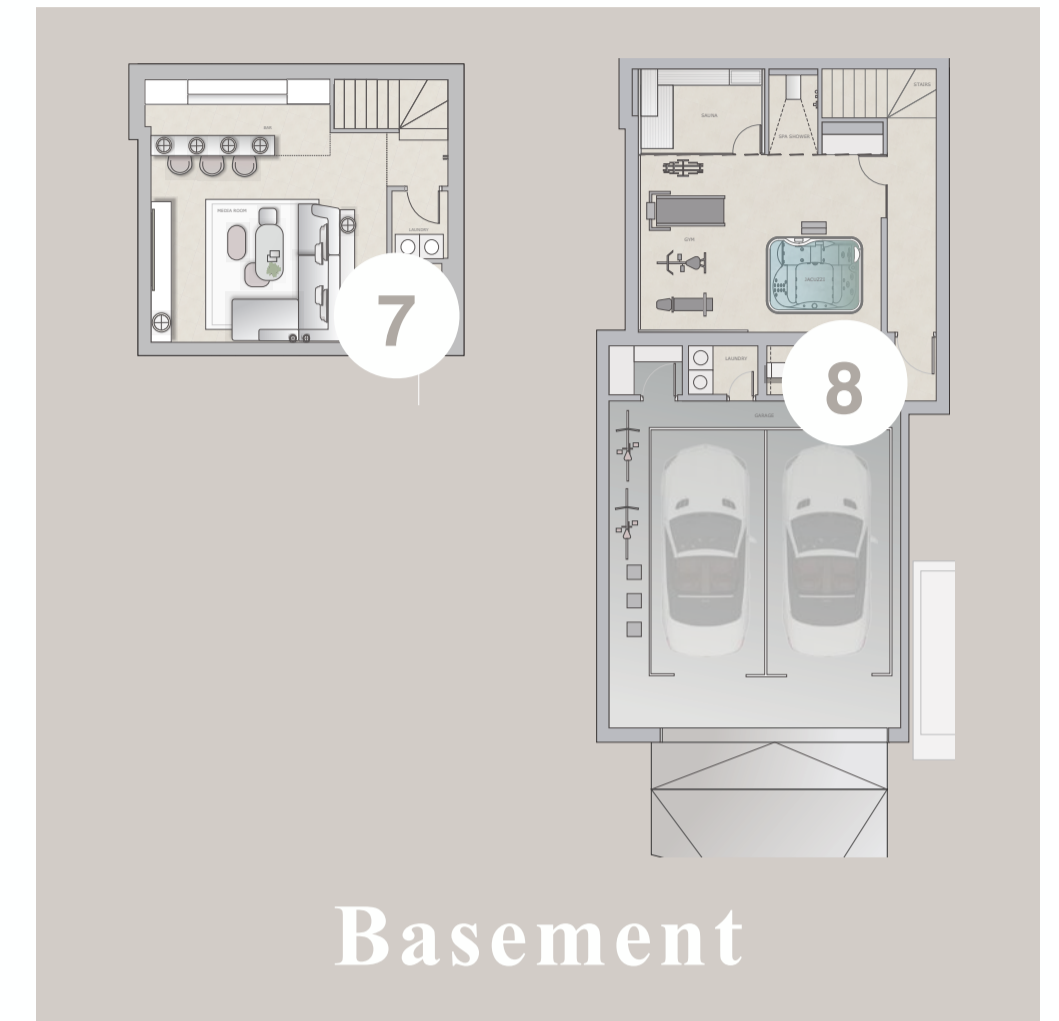
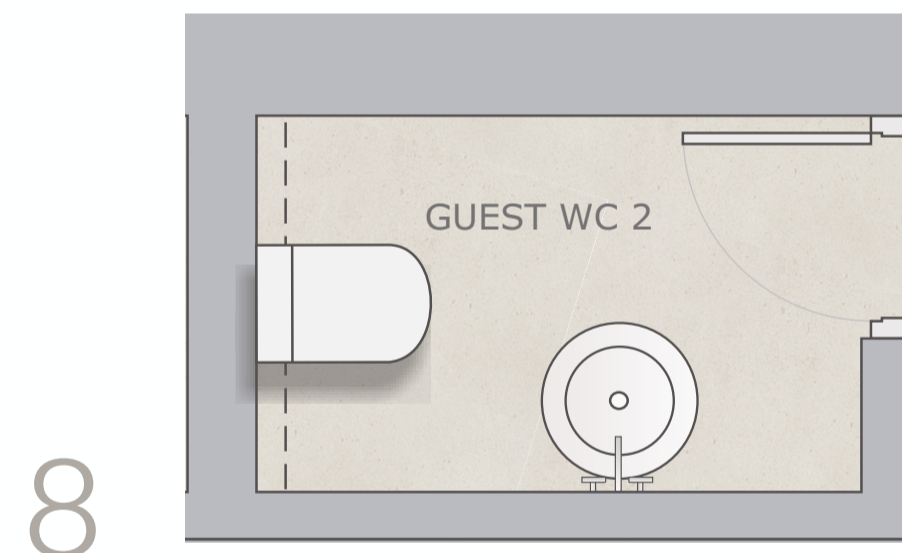
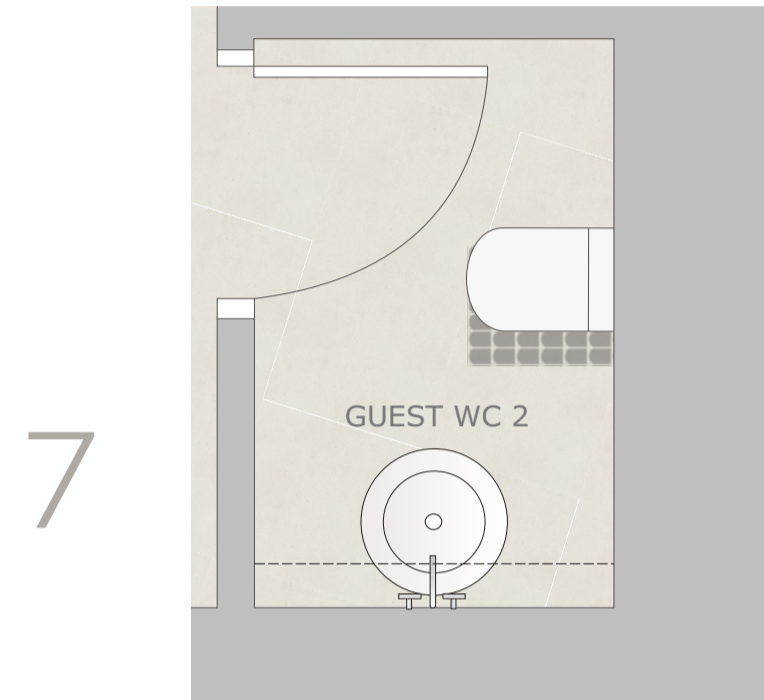

All bathrooms are fully fitted with ceramics by Duravit, known for its seamless design, high quality, and impressive durability.

A Toilet ME by Starck white DURAVIT with Glass White actuator plate B Paffoni Bidet Kit C DURAVIT White Tulip Vanity Unit D DURAVIT White Tulip Single Lever Basin Mixer



Villa A+

STANDARD  
EQUIPMENT  
GUIDE

LIOQA  
RESORT





STANDARD  
EQUIPMENT  
GUIDE

**LIOQA**  
RESORT

[info@lioqa.com](mailto:info@lioqa.com)  
[www.lioqa.com](http://www.lioqa.com)

This document may be subject to changes arising from the requirements agreed by the Seller and the Buyer, the requirements of the relevant public authorities, the requirements prescribed by the Categorisation and other relevant applicable laws, and the changes in the main design and detailed design of the Project (Project Documentation).